

PLUS

Negli oggetti di uso quotidiano la ricerca del segno formale rende talvolta secondaria la funzionalità. Piet Billekens ha ristabilito nel progetto PLUS l'equilibrio tra concetto e funzione, disegnando complementi d'arredo non subordinati a stili o tendenze. Massima attenzione ai materiali e peculiare controllo dei processi di lavorazione sono garantiti da Colombo Design che condivide il concetto di qualità totale.

Sometimes the research of a formal design in everyday used objects might give to functionality a secondary role. Thanks to Arch. Piet Billekens the project Plus has re-established the balance between concept and function, designing furnishing complements free from any style or trend. The highest attention was also given to the materials, with a peculiar control to the manufacturing process granted by Colombo Design that shares the common concepts of total quality.





“Senza entusiasmo non si è mai compiuto niente di grande.”

“Nothing great was ever achieved without enthusiasm.”

Ralph W. Emerson

W49PZ



W4916





W4980XL



W4940 - W4980 - W4941





W4914



W4913



W4915

W4975 + B523M









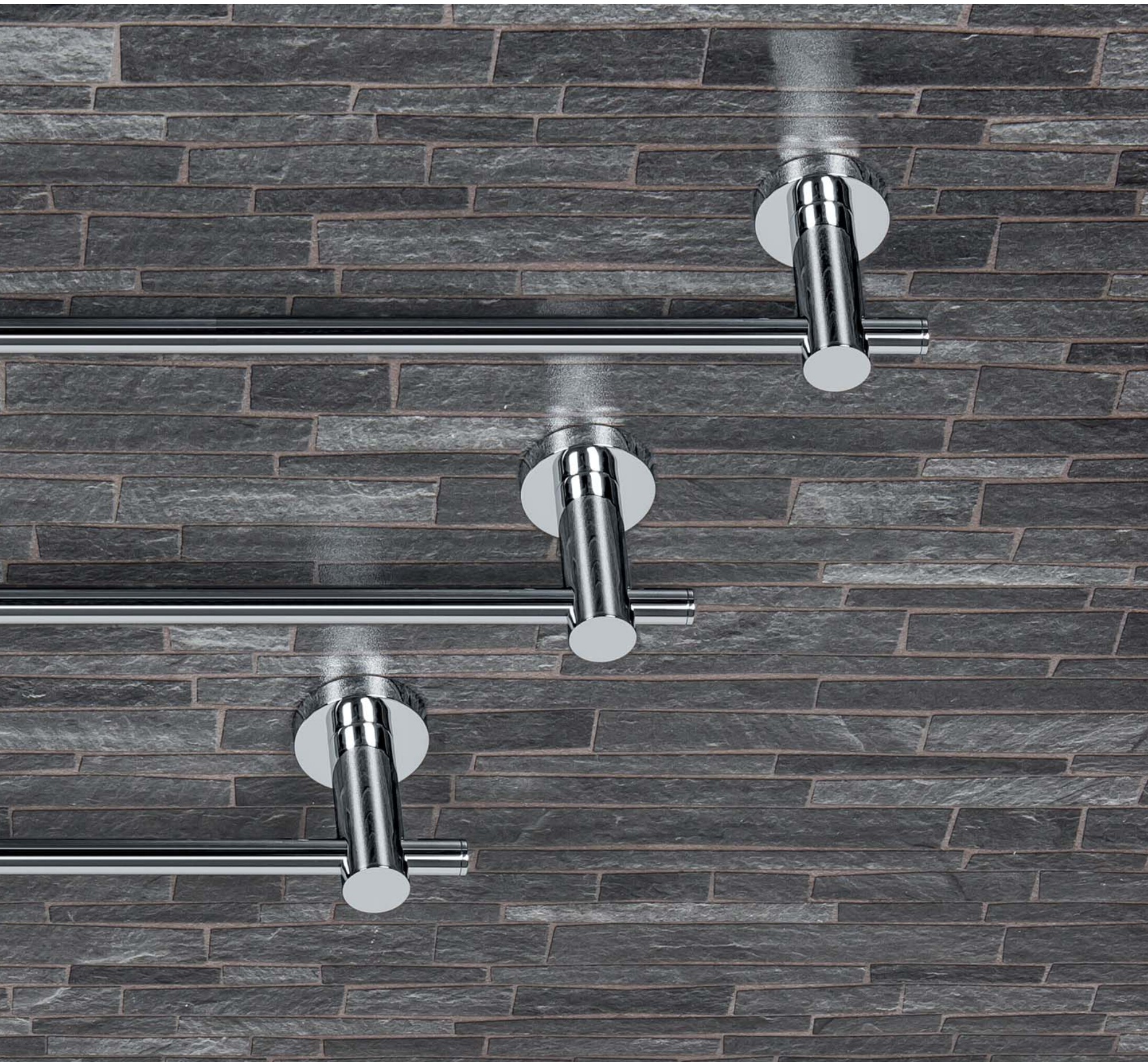

W4917







W4908DX

W4990



W4908

W4992



W4961
W4962

W4987







W4935

W4938

W4936



PLUS

Design: Piet Billekens

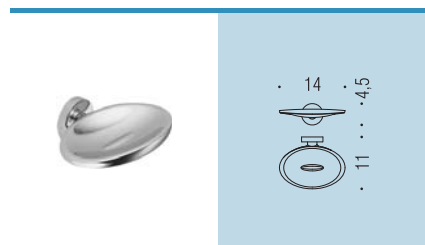

W4901
Porta sapone
inamovibile
Irremovable
soap dish holder

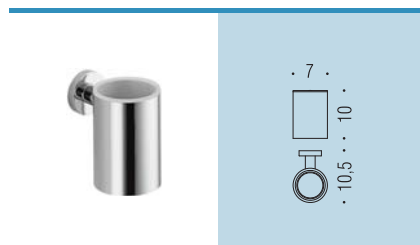
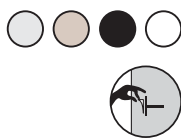

W4902
Porta bicchiere
inamovibile
Irremovable
glass holder

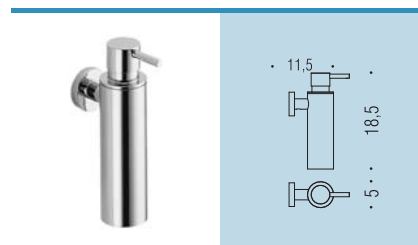
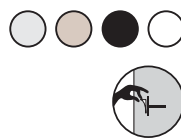

W4981
Spandisapone
(L 0,15)
Soap dispenser

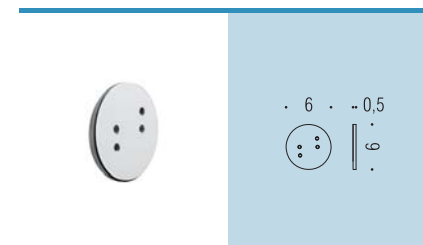
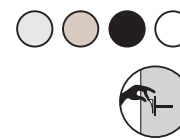

B523M
Ghiera
con bi-adesivo
Ring with adhesive

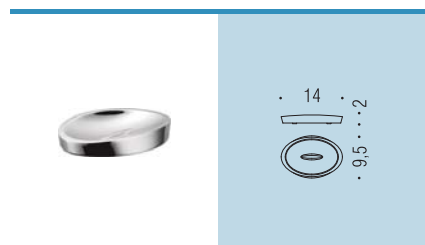

W4940
Porta sapone
d'appoggio
Standing soap dish holder

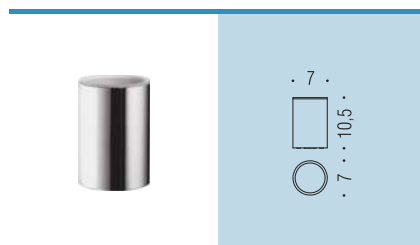

W4941
Porta bicchiere
d'appoggio
Standing glass holder

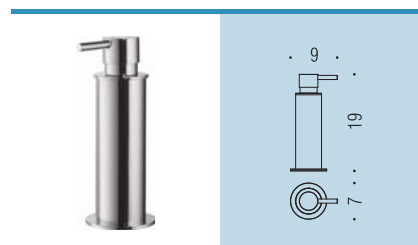

W4980
Spandisapone (L 0,15)
d'appoggio
Standing soap dispenser

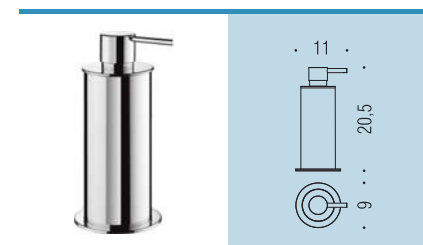

W4980XL
Spandisapone
JUMBO (L 0,5) d'appoggio
Standing soap dispenser
JUMBO version (L 0,5)

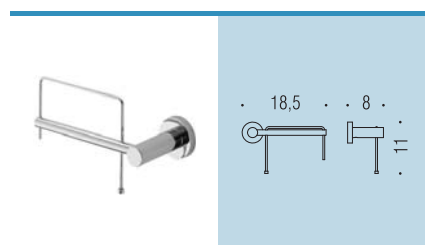

W4908DX - W4908SX
Porta rotolo
Paper holder

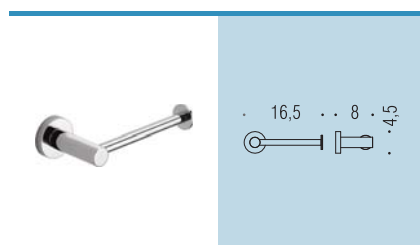

W4908
Porta rotolo
Paper holder

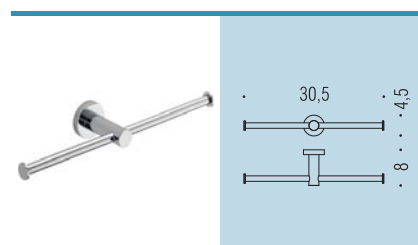
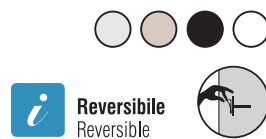

W4990
Porta rotolo doppio
Double Paper holder

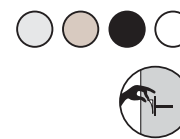

W4992
Porta rotolo
Paper holder

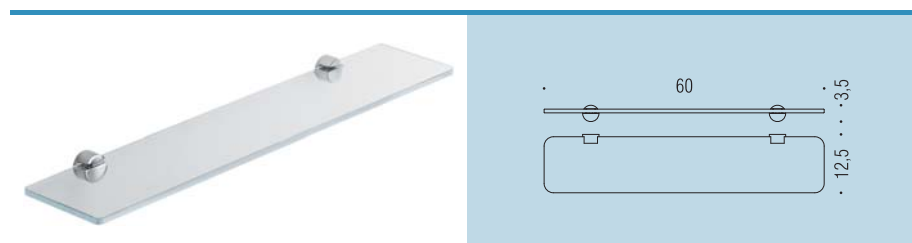

W4916
Mensola
Shelf

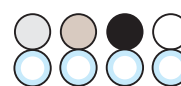

W49PZ
Reggimensola
Shelf holder



W4917
Appenditutto
Hook

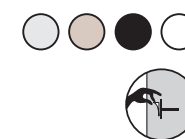

Materiale: Ottone / Cromall®
Material: Brass / Cromall®

Finiture:  Cromo
Finishes:  Chrome  Zirconium
Stainless Steel  Nero
opaco  Bianco
opaco
Matt black Matt white

Complementi:  Vetro trasparente
Complements:  Transparent glass  Metacrilato
Methacrylate



La collezione Plus è fornita completa di viti, tasselli e brugole di montaggio. OPTIONAL Esiste altresì la possibilità di utilizzare per ogni punto di fissaggio un kit con biadesivo (Art. B523M). Il biadesivo è premontato sul pezzo e, per la preparazione della superficie del muro, all'interno della confezione sono presenti un kit di pulizia ed uno stick con il primer/attivatore. **Attenzione:** si sconsiglia l'applicazione dei pezzi su superfici particolarmente ruvide o poco compatte, così come su intonaci o muri grezzi.

Our Plus collection is delivered complete with screws, plugs and Allen key. OPTIONAL Wall fixing with adhesive is available. Please ask for the correct component for each fixing point (Art. B523M). Adhesive strips are already preassembled on the piece and, for the preparation of the wall surface, inside the box there is a cleaning kit and a stick with the activator/primer. **Attention:** we do not recommend the application of the pieces on surfaces particularly rough, as well as on painted walls.

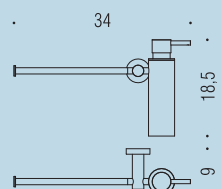

W4975
Spandisapone (L 0,15) e porta salvietta per bidet reversibile
Reversible soap dispenser and towel holder for bidet

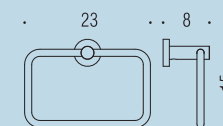

W4931
Porta salvietta ad anello
Ring towel holder

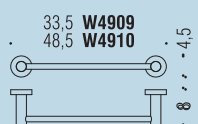

W4909 - W4910
Porta salvietta
Towel holder

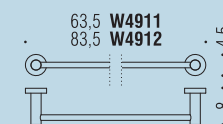

W4911 - W4912
Porta salvietta
Towel holder

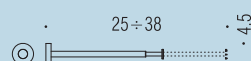

W4915
Porta salvietta estensibile
Extensible towel holder

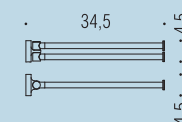

W4913
Porta salvietta doppio a snodo
Double bar towel holder



PLUS

Design: Piet Billekens

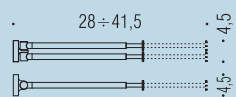

W4914
Porta salviette doppio estensibile a snodo
Extensible double bar towel holder

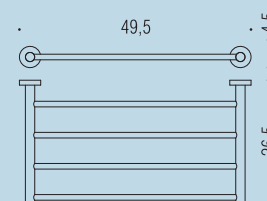

W4987
Rack porta salvietta
Rack towel holder

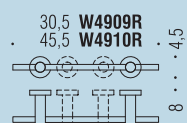

W4909R - W4910R
Porta salvietta con supporti regolabili
Towel holder, adjustable supports

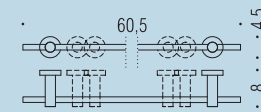

W4911R
Porta salvietta con supporti regolabili
Towel holder, adjustable supports

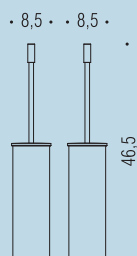

W4961
Porta scopino d'appoggio
Standing brush holder

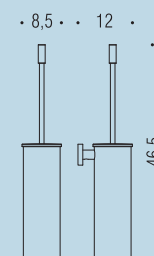

W4962
Porta scopino
Hanging brush holder



Materiale: Ottone / Cromall®
Material: Brass / Cromall®

Finiture: Cromo Zirconium Nero Bianco
Finishes: Chrome Stainless Steel Matt black Matt white

Complementi: Vetro trasparente Metacrilato
Complements: Transparent glass Methacrylate

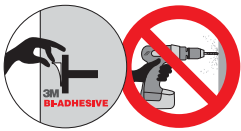

La collezione Plus è fornita completa di viti, tasselli e brugole di montaggio. **OPTIONAL** Esiste altresì la possibilità di utilizzare per ogni punto di fissaggio un kit con biadesivo (Art. B523M). Il biadesivo è premontato sul pezzo e, per la preparazione della superficie del muro, all'interno della confezione sono presenti un kit di pulizia ed uno stick con il primer/attivatore. **Attenzione:** si sconsiglia l'applicazione dei pezzi su superfici particolarmente ruvide o poco compatte, così come su intonaci, resine e muri grezzi.

Our Plus collection is delivered complete with screws, plugs and Allen key. **OPTIONAL** Wall fixing with adhesive is available. Please ask for the correct component for each fixing point (Art. B523M). Adhesive strips are already preassembled on the piece and, for the preparation of the wall surface, inside the box there is a cleaning kit and a stick with the activator/primer. **Attention:** we do not recommend the application of the pieces on surfaces particularly rough, resin as well as on painted walls.

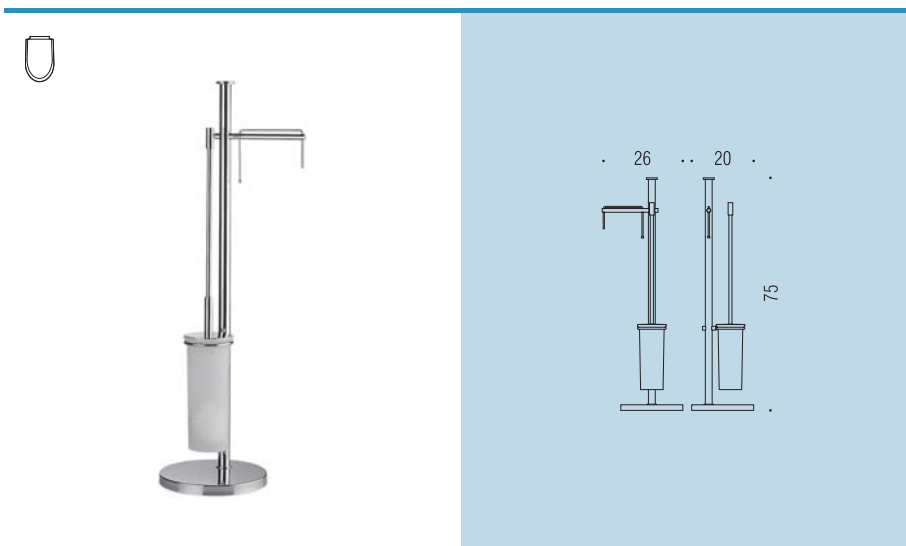

W4935

Piantana con porta rotolo e porta scopino

Standing column equipped with paper holder and brush holder

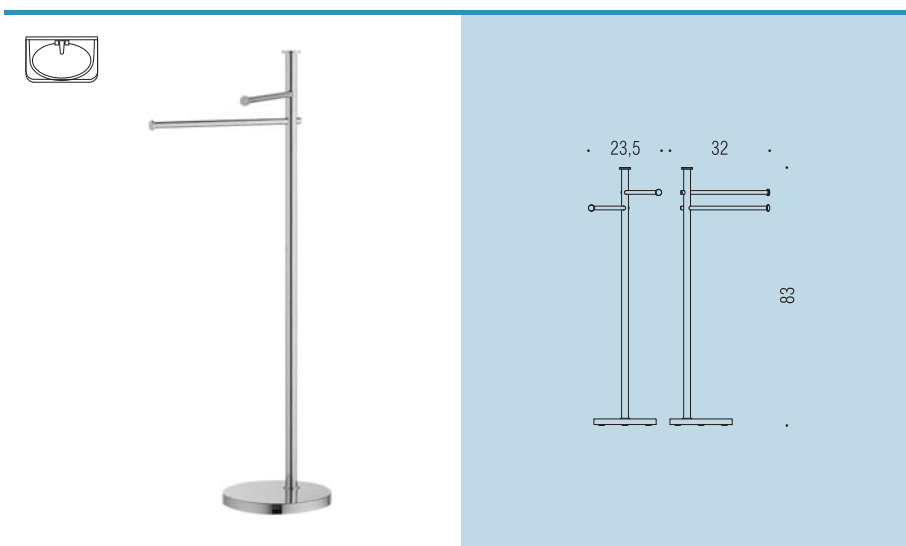

W4936

Piantana con due porta salvietta

Standing column equipped with two towel holders

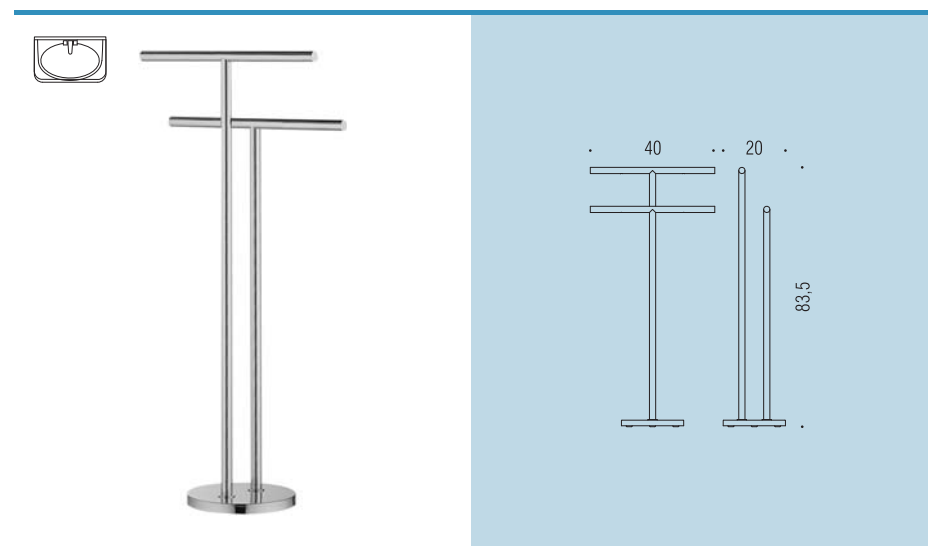

W4938

Piantana con due porta salvietta

Standing column equipped with two towel holders

